

P2900-IW Kit A P6900-IW Kit A P2915 Kit A/B P2925 Kit A/B

ANPR Camera Housing



P2900-IW Kit A
P6900-IW Kit A



P2915 Kit A/B
P2925 Kit A/B

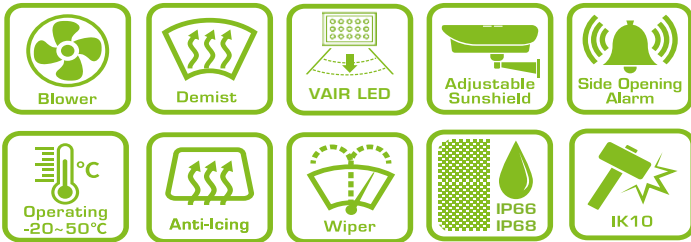

Model

	P2900-IW Kit A	P6900-IW Kit A	P2915 Kit A/B	P2925 Kit A/B
IR Illuminator Specifications				
IR lights catch vehicle speed	MAX: 100km/h (62MPH)	MAX: 100km/h (62MPH)	MAX: 150km/h (93MPH)	MAX: 250km/h (156MPH) *fit Global shutter camera like equipped with Sony IMX264 or IMX265 sensor
IR lights cover FOV	2 Lanes	2 Lanes	2 Lanes	2 Lanes
VAIR light beam angle	10° ~ 30°	10° ~ 30°	10° ~ 40° Kit A 20° ~ 40° Kit B	10° ~ 40° Kit A 20° ~ 40° Kit B
Adjustable angle way	<ul style="list-style-type: none"> Manual DIP Remote control by Pelco D via RS485 	<ul style="list-style-type: none"> Manual DIP Remote control by Pelco D via RS485 	<ul style="list-style-type: none"> Manual DIP Remote control by Pelco D via RS485 	<ul style="list-style-type: none"> Manual DIP Remote control by Pelco D via RS485
IR light sensor sensitivity	Pelco D via RS485	Pelco D via RS485	<ul style="list-style-type: none"> Pelco D via RS485 Remote controller 	<ul style="list-style-type: none"> Pelco D via RS485 Remote controller
Power consumption	48W	48W	80W	24W (288W pulse mode)
Power input	DC24V	DC24V	AC24V or DC24V	DC24V
Camera Housing Specifications				
Window heater	V	V	V	V
Blower	V	V	V	V
Wiper	V	V	-	-
Weather rating	IP66	IP66	IP68	IP68
Power input	AC24V	95W UPoE	AC24V	AC24V
Power output	DC24V, DC12V	DC24V, PoE	DC24V, DC12V	DC24V, DC12V
Power consumption	72W	72W	100W	44W (288W Pulse Mode)
Vandal proof	IK10	IK10	IK10	IK10
Operating temperature	-20°C ~ +50°C (-4°F~122°F)	-20°C ~ +50°C (-4°F~122°F)	-20°C ~ +50°C (-4°F~122°F)	-20°C ~ +50°C (-4°F~122°F)
Optional add-on heater Operating temperature	-50°C ~ +50°C (-58°F~122°F) P2900-AIW is available	N/A	-50°C ~ +50°C (-58°F~122°F) P2915-A is available	-50°C ~ +50°C (-58°F~122°F) P2925-A is available

Features

VAIR LEDs Technology

VAIR technology is an optical technology to adjust illuminator beam angle by remote control thru RS485 Pelco-D command to suit diversified camera FOV.

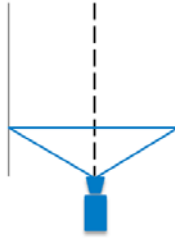
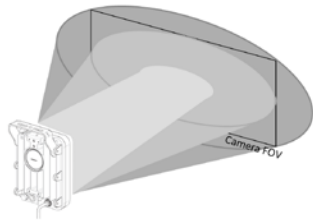

Wide angle for short distance

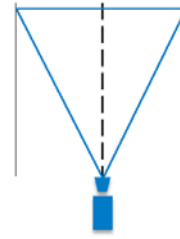

Tele angle for long distance

Capacious dimensions



AXIS Q1635 equipped with 8-80mm varifocal lens



Avigilon 8.0-H4A-B2 IP Camera

Dimensions

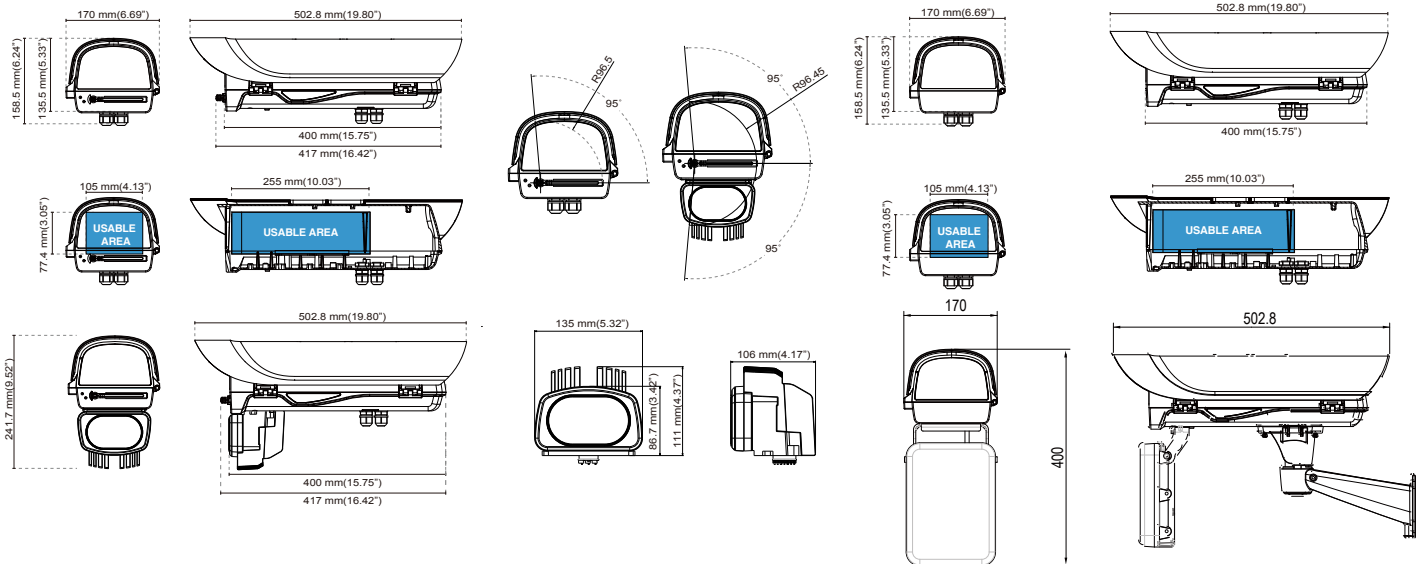



Related Product

Power Boxes Fits P2900-IW Kit A, P2915 Kit A/B, P2925 Kit A/B

Outdoor Power Box		Outdoor Power Box / Junction Box	
	<p>PB-024-1AC Outdoor Power Box</p> <ul style="list-style-type: none"> • IP67/IK10 • 115VAC / 230VAC Input • 24VAC/6A Output • -40°C ~ 60°C 		<p>PB-024-2AC Outdoor Power/Junction Box</p> <ul style="list-style-type: none"> • IP67/IK10 • 115VAC / 230VAC Input • 24VAC/6A Output • -40°C ~ 60°C



PoE Injector Fits P6900-IW Kit A

Indoor PoE Injector		Outdoor PoE Injector		Outdoor PoE Injector / Junction Box	
	I39-100 <ul style="list-style-type: none"> ● 1xGbE 95W UPoE ● 100~240VAC 		I49-100 <ul style="list-style-type: none"> ● 1xGbE 95W UPoE ● 100~240VAC ● IP67/IK10 ● -40°C ~ 60°C 		I49-101 <ul style="list-style-type: none"> ● 1xGbE 95W UPoE ● 100~240VAC ● IP67/IK10 ● -40°C ~ 60°C

Industrial PoE Switch Fits P6900-IW Kit A

PoE Switches	
	H30-044-90 <ul style="list-style-type: none"> ● 4xGbE UPoE + 2xGbE SFP + 2xGbE RJ45

Mount Brackets Fits PB-024-2AC, I49-100, I49-101

Pole Mount		Corner Mount
		
AT-100 Pole Mount Adapter	AT-101 Pole Mount Adapter	AT-200 Corner Mount Adapter